

*KSG-120CL-M0/M3*

PV Grid-Connected Inverter

## *User Manual*

## All Rights Reserved

### **All Rights Reserved**

No part of this document can be reproduced in any form or by any means without the prior written permission of Shenzhen Kstar New Energy Company Limited (hereinafter "KSTAR").

### **Trademarks**

**KSTAR** and other KSTAR trademarks used in this manual are owned by Shenzhen Kstar New Energy Company Limited.

All other trademarks or registered trademarks mentioned in this document are owned by their respective owners.

### **Software Licenses**

- It is prohibited to use data contained in firmware or software developed by KSTAR, in part or in full, for commercial purposes by any means.
- It is prohibited to perform reverse engineering, cracking, or any other operations that compromise the original program design of the software developed by KSTAR.

## About This Manual

The manual mainly describes the product information, guidelines for installation, operation and maintenance. The manual cannot include complete information about the photovoltaic (PV) system. You can get additional information about other devices at [www.kstar.com](http://www.kstar.com) or on the webpage of the respective component manufacturer.

### Validity

This manual is valid for the following inverter types:

- KSG-120CL-M0/M3
- They will be referred to as “inverter” hereinafter unless otherwise specified.

### Target Group

This manual is intended for:



- qualified personnel who are responsible for the installation and commissioning of the inverter;
- inverter owners who will have the ability to interact with the inverter.

### How to Use This Manual

Read the manual and other related documents before performing any work on the inverter is carried out. Documents must be stored carefully and be available at all times. The contents of the manual will be periodically updated or revised due to the product development. It is probably that there are changes of manual in the subsequent inverter edition. The latest manual can be acquired via visiting the website at [www.kstar.com](http://www.kstar.com).

### Symbols

Important instructions contained in this manual should be followed during installation, operation and maintenance of the inverter. They will be highlighted by the following symbols.

Symbol	Explanation
 <b>DANGER</b>	Indicates a hazard with a high level of risk that, if not voided, will result in death or serious injury.
 <b>WARNING</b>	Indicates a hazard with a medium level of risk that, if not avoided, could result in death or serious injury.
 <b>CAUTION</b>	Indicates a hazard with a low level of risk that, if not avoided, could result in minor or moderate injury.

Symbol	Explanation
<b>NOTICE</b>	Indicates a situation that, if not avoided, could result in equipment or property damage.
	Indicates additional information, emphasized contents or tips that may be helpful, e.g. to help you solve problems or save time.

# Contents

---

All Rights Reserved.....	I
About This Manual.....	II
<b>1 Safety</b> .....	1
1.1 PV Panels.....	1
1.2 Utility Grid.....	1
1.3 Inverter.....	2
1.4 Skills of Qualified Personnel.....	3
<b>2 Product Introduction</b> .....	4
2.1 Intended Usage.....	4
2.2 Product Introduction.....	5
2.2.1 Model Description.....	5
2.2.2 Appearance.....	6
2.2.3 Dimensions.....	6
2.2.4 LED Board.....	7
2.2.5 DC Switch.....	7
2.3 Circuit Diagram.....	7
2.4 Function Description.....	8
<b>3 Unpacking and Storage</b> .....	10
3.1 Unpacking and Inspection.....	10
3.2 Identifying the Inverter.....	10
3.3 Scope of Delivery.....	12
3.4 Inverter Storage.....	12
<b>4 Mechanical Mounting</b> .....	14
4.1 Safety during Mounting.....	14
4.2 Location Requirements.....	14
4.2.1 Installation Environment Requirements.....	14
4.2.2 Carrier Requirements.....	15
4.2.3 Installation Angle Requirements.....	15
4.2.4 Installation Clearance Requirements.....	16
4.3 Installation Tools.....	18
4.4 Moving the Inverter.....	19

4.4.1 Manual Transport.....	19
4.4.2 Hoisting Transport.....	19
4.5 Dimensions of mounting-bracket.....	20
4.6 PV Bracket-Mounted Installation.....	21
4.6.1 Preparation before Mounting.....	21
4.6.2 Mounting Steps.....	21
4.7 Wall-Mounted Installation.....	23
4.7.1 Preparation before Mounting.....	23
4.7.2 Mounting Steps.....	23
<b>5 Electrical Connection</b> .....	<b>26</b>
5.1 Safety Instructions.....	26
5.2 Terminal Description.....	26
5.3 Electrical Connection Overview.....	28
5.4 Additional Grounding Connection.....	30
5.4.1 Additional Grounding Requirements.....	30
5.4.2 Connection Procedure.....	30
5.5 Opening the Wiring Compartment.....	31
5.6 AC Cable Connection.....	32
5.6.1 AC Side Requirements.....	32
5.6.2 Requirements for OT/DT Terminal.....	34
5.6.3 Aluminium Cable Requirements.....	34
5.6.4 Connection Procedure.....	35
5.7 DC Cable Connection.....	38
5.7.1 PV Input Configuration.....	39
5.7.2 Connection Procedure.....	40
5.7.3 Installing the PV Connectors.....	41
5.8 RS485 Communication.....	42
5.8.1 Interface Description.....	42
5.8.2 RS485 Communication System.....	42
5.8.3 Connection Procedure(Terminal Block).....	43
5.9 PLC Communication Connection.....	45
5.10 Wiring of Tracking System Power Cable(Optional).....	45
5.11 Closing the Wiring Compartment.....	46
<b>6. Commissioning</b> .....	<b>47</b>
6.1 Inspection before Commissioning.....	47
6.2 Commissioning Procedure.....	47

<b>7. Bluetooth APP Settings</b> .....	<b>48</b>
7.1 Overview.....	48
7.2 APP download.....	48
7.3 Bluetooth connection.....	48
7.4 Basic information interface.....	50
7.5 Query interface.....	51
7.6 Setting interface.....	51
7.6.1 Set page information.....	53
7.6.2 Related parameters setting interface.....	54
7.6.3 Set parameter information.....	55
7.7 Statistics interface.....	58
<b>8 System Decommissioning</b> .....	<b>59</b>
8.1 Disconnecting the Inverter.....	59
8.2 Dismantling the Inverter.....	60
8.3 Disposal of the Inverter.....	60
<b>9 Troubleshooting and Maintenance</b> .....	<b>61</b>
9.1 Error and alarm.....	61
9.1.1 Inverter system error type analysis and solution.....	62
9.2 Error and alarm.....	65
9.2.1 Routine Maintenance.....	66
9.2.2 Maintenance Instruction.....	66
<b>10 Appendix</b> .....	<b>69</b>
10.1 Technical Data.....	69
10.2 Quality Assurance.....	71
10.3 Contact Information.....	71

# 1 Safety

The inverter has been designed and tested strictly according to international safety regulations. Read all safety instructions carefully prior to any work and observe them at all times when working on or with the inverter.

Incorrect operation or work may cause:

- injury or death to the operator or a third party;
- damage to the inverter and other property safety of the operator or a third party.

All detailed work-related safety warnings and notes will be specified at critical points in this manual.



The safety instructions in this manual cannot cover all the precautions that should be followed. Perform operations considering actual onsite conditions. KSTAR shall not be held liable for any damage caused by violation of the safety instructions in this manual.

## 1.1 PV Panels

### **⚠ DANGER**

**PV strings will produce electrical power when exposed to sunlight and can cause a lethal voltage and an electric shock.**

- **Always keep in mind that the inverter is dual power supplied. electrical operators must wear proper personal protective equipment: helmet, insulated footwear, glove, etc.**
- **Before touching the DC cables, operator must use a measuring device to ensure that the cable is voltage-free.**
- **Must follow all warnings on the PV strings and in its manual.**

## 1.2 Utility Grid

Please follow the regulations related to the utility grid.

**NOTICE**

All electrical connections must be in accordance with local and national standards.  
 Only with the permission of the utility grid, the inverter can be connected to the utility grid.

### 1.3 Inverter

**⚠ DANGER**

**Danger to life from electric shocks due to live voltage**

- Do not open the enclosure at any time. Unauthorized opening will void guarantee and warranty claims and in most cases terminate the operating license.

**⚠ WARNING**

**Risk of inverter damage or personal injury**

- Do not pull out the PV connectors when the inverter is running.
- Wait at least 5 minutes for the internal capacitors to discharge. Ensure that there is no voltage or current before pulling any connector.

**⚠ WARNING**

**All safety instructions, warning labels, and nameplate on the inverter:**

- Must be clearly legible.
- Should not be removed or covered.

**⚠ CAUTION**

**Risk of burns due to hot components!**  
 Do not touch any hot parts (such as heat sink) during operation. Only the DC switch can safely be touched at any time.

**NOTICE**





Only qualified personnel can perform the country setting.

- Unauthorized alteration of the country setting may cause a breach of the type-certificate marking.

By touching the electronic components, you may damage the inverter. For inverter handling, be sure to:

- avoid any unnecessary touching;
- wear a grounding wristband before touching any connectors.

Warning Label

Label	Description
	Danger to life due to high voltages! Only qualified personnel can open and service the inverter.
	Caution, risk of electric shock, energy storage timed discharge.
	Caution, hot surface.
	Caution, risk of electric shock.
	Check the user manual before service!

### 1.4 Skills of Qualified Personnel

All installations should be performed by qualified personnel. They should have:

- Training in the installation and commissioning of the electrical system, as well as the dealing with hazards;
- Knowledge of the manual and other related documents;
- Knowledge of the local regulations and directives.

## 2 Product Introduction

### 2.1 Intended Usage

KSG-120CL-M0/M3, a transformerless three-phase PV grid-connected inverter, is an integral component in the PV power system.

The inverter is designed to convert the direct current power generated from the PV modules into grid-compatible AC current and feeds the AC current to the utility grid.

The intended usage of the inverter is illustrated in "figure 2-1 Inverter application in PV power system".

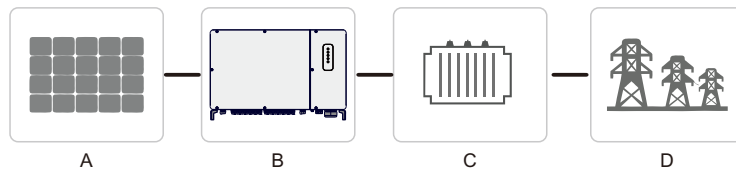

figure 2-1 Inverter application in PV power system

**⚠ WARNING**

**Inverter cannot connect the PV strings whose positive and negative terminals need to be grounded.  
Do not connect any local load between the inverter and the AC circuit breaker.**

Item	Description	Note
A	PV strings	Monocrystalline silicon, polycrystalline silicon and thin-film without grounding.
B	Inverter	KSG-120CL-M0/M3
C	Transformer	Boost the low voltage from inverter to grid-compatible medium voltage.
D	Utility grid	3W+N+PE,3W+PE

### 2.2 Product Introduction

#### 2.2.1 Model Description

The device model description is as follows:

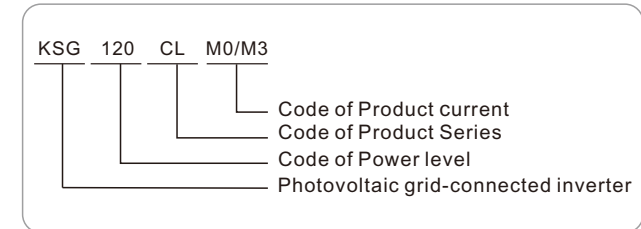

Model	Nominal Output Power	Nominal Grid Voltage
KSG-120CL-M0/M3	110KW@ 45 °C 121KW@25 °C	3W+PE(default),3W+N+PE(configurable)

The device model can be found on the nameplate attached to the side of the inverter. For details, refer to "3.2 Identifying the Inverter".



### 2.2.2 Appearance

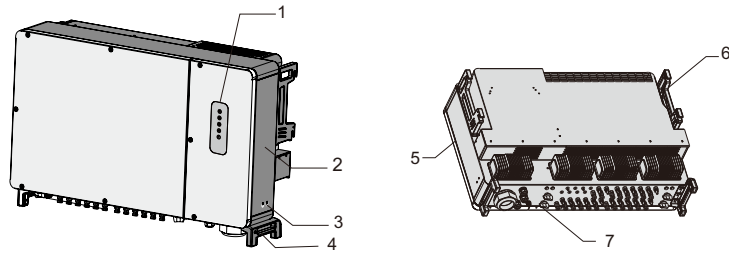

\*The image shown here is for reference only. The actual product you receive may differ.

No.	Name	Description
1	LED controlled panel	HMI interface to indicate the present working state of the inverter.
2	Labels	Nameplate.
3	Additional grounding terminals	use at least one of them to ground the inverter.
4	Bottom handles	used to move the inverter.
5	Side handles	used to move the inverter.
6	Mounting ears	used to hang the inverter onto the mounting-bracket.
7	Wiring area	DC switches, AC terminals, DC terminals, and communication terminals. For details, refer to "5.2 Terminal Description".

### 2.2.3 Dimensions

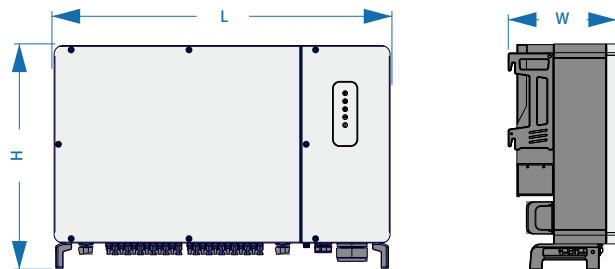

figure 2-2 Dimensions of the Inverter

\*The image shown here is for reference only. The actual product you receive may differ.

Type	Dimensions (W*H*D)	Weight
KSG-120CL-M0/M3	1055*700*336mm	93kg

### 2.2.4 LED board

Five LEDs are set on the board of the inverter, as shown in Fig.

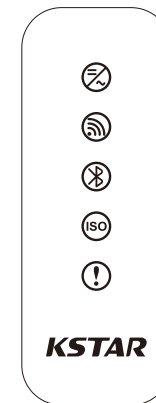

LED board

Table 2.2.4 LED lamp description

LED lamp	Color	LED state	Meaning
		Always on	Normal grid-connected operation
	Green	Flicker in cycle	There is power of DC or AC, but there is no grid-connected operation.
		Off	AC and DC are both disconnected with power.
	Blue	Flicker for once	Communication for once
		Off	No signal
	Blue	Always on	Bluetooth communication is connected.
		Flicker	Bluetooth communication is not connected.

Table 2.2.4 LED lamp description

LED lamp	Color	LED state	Meaning
ISO	Yellow	Always on	Low insulation resistance
		Off	Normal insulation resistance
		Slow flicker	Low-level alarm
!	Red	Fast flicker	Middle-level alarm
		Always on	High-level alarm
!	Green	Always on	In maintenance
		OFF	No abnormal state

### 2.2.5 DC Switch

The DC switch is used to disconnect the DC current safely whenever necessary. The KSG-120CL-M0/M3 is equipped with four DC switches, each DC switch controls its corresponding DC terminals.

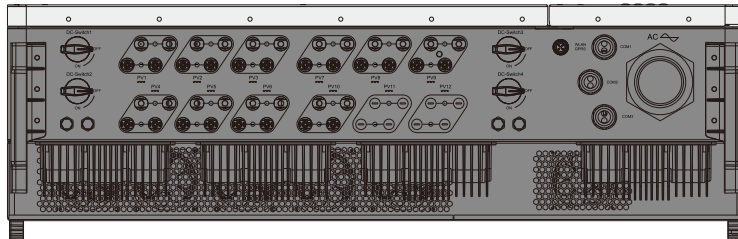

**i** Turn the DC switches to the ON position before restarting the inverter.

### 2.3 Circuit Diagram

The MPPT is utilized for DC input to ensure the maximum power from the PV array at different PV input conditions. The inversion circuit converts the DC power into AC power and feeds the AC power into the utility grid through the AC terminal. The protection circuit is equipped to ensure the safe operation of the device and personal safety. The following figure shows the main circuit of the inverter.

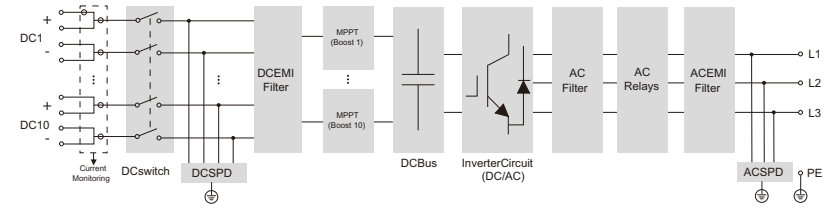

figure 2-3 Circuit diagram

**i** KSG-120CL-M3 inverter is equipped with 7 MPPT.

### 2.4 Function Description

The inverter is equipped with the following functions:

#### Conversion function

The inverter converts the DC current into grid-compatible AC current and feeds the AC current into the grid.

#### Data storage

The inverter logs running information, error records, etc.

#### Parameter configuration

The inverter provides various settable parameters. Users can set parameters via the APP to meet the requirements and optimize the performance.

#### Communication interface

The inverter is designed with standard RS485 communication interfaces. The standard RS485 communication interfaces are used to establish communication connection with monitoring devices and upload monitoring data by using communication cables.

After communication connection is established, users can view inverter information or set inverter parameters through the KstarCloud.

#### Protection Function

The protective functions are integrated in the inverter, including anti-island protection, LVVRT/ZVRT, DC reversed polarity protection, AC short circuit protection, leakage current protection, DC overvoltage/overcurrent protection, etc.

### 3 Unpacking and Storage

#### 3.1 Unpacking and Inspection

The inverter is thoroughly tested and strictly inspected before delivery. Damage may still occur during shipping. Conduct a thorough inspection after receiving the device.

- Check the packing for any visible damage.
  - Check the inner contents for damage after unpacking.
  - Check the delivery scope for completeness according to the packing list.
- Contact KSTAR or the supplier in case there is any damage or incompleteness. Do not dispose of the original packing case. It is recommended to store the inverter in it.

#### 3.2 Identifying the Inverter

The nameplate can be found on both the inverter and the packing case. It provides information on type of inverter, important specifications, marks of certification institutions, and serial number which are available and identified by KSTAR.

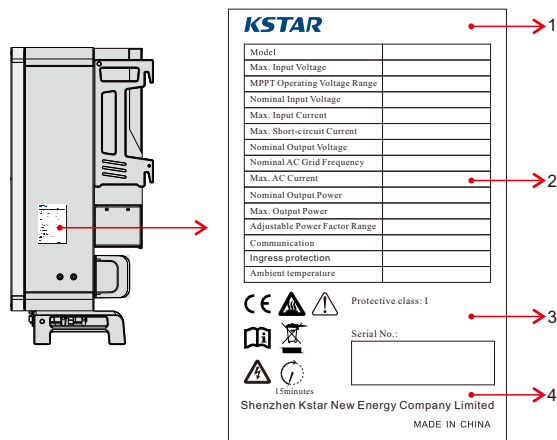

figure 3-1 Nameplate of Inverters

\* The image shown here is for reference only. The actual product you receive may differ.

Item	Description
1	KSTAR logo and product type
2	Technical data of inverter
3	Icon
4	Company name

table 3-1 Description of Icons on the Nameplate

Icon	Description
	Do not dispose of the inverter together with household waste.
	Refer to the corresponding instructions.
	CE mark of conformity.

### 3.3 Scope of Delivery

Item	Description	Model	Unit	Qty.	Check	Remarks
1	Inverter		PC	1	<input checked="" type="checkbox"/>	
2	User manual		PC	1	<input checked="" type="checkbox"/>	
3	Quick install manual		PC	1	<input checked="" type="checkbox"/>	
4	Certificate of Approval		PC	1	<input checked="" type="checkbox"/>	
5	Warranty Card		PC	1	<input checked="" type="checkbox"/>	
6	PV connection terminal (+)		PC	20	<input checked="" type="checkbox"/>	
7	PV connection terminal (-)		PC	20	<input checked="" type="checkbox"/>	
8	Terminal		PC	6	<input checked="" type="checkbox"/>	
9	Heat shrinkable casing		PC	4	<input checked="" type="checkbox"/>	
10	Bolt(M10)		PC	4	<input checked="" type="checkbox"/>	
11	Mounting-bracket(2 mounting-bracket components and 1 connecting bar )		PC	1	<input checked="" type="checkbox"/>	
12	Combination screw (M6)		PC	2	<input checked="" type="checkbox"/>	
13	Combination screw (M4)		PC	2	<input checked="" type="checkbox"/>	
14	Spanner(used for removing the PV connector)		PC	1	<input checked="" type="checkbox"/>	
15	L-type spanner(used for removing the cover)		PC	1	<input checked="" type="checkbox"/>	

**Note:** the number of KSG-120CL-M3 PV connection terminals (+,-) is 14.

### 3.4 Inverter Storage

Proper storage is required if the inverter is not installed immediately.

- Store the inverter in the original packing case .
- The storage temperature must be always between -40° C and +70° C, and the storage relative humidity must be always between 0 and 95%, non-condensing.
- In case of stacking storage, the number of stacking layers should never exceed the limit marked on the outer side of the packing case.

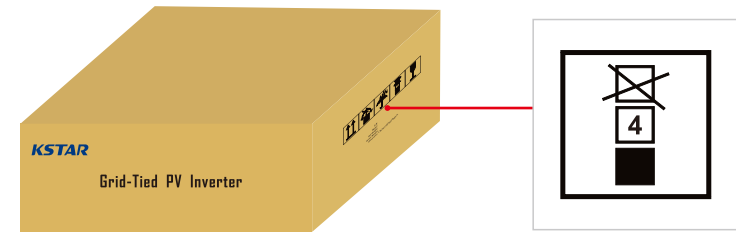

- The packing case should be upright.
- If the inverter has been stored more than half a year, the qualified personnel should thoroughly check and test it before using.

## 4 Mechanical Mounting

### 4.1 Safety during Mounting

**⚠ DANGER**

Make sure there is no electrical connection before installation. In order to avoid electric shock or other injury, be sure there is no electricity or plumbing installations before drilling holes.

**⚠ CAUTION**

Risk of injury due to improper handling

- Always follow the instructions when moving and positioning the inverter.
- Improper operation may cause injuries, serious wounds, or bruise. System performance loss due to poor ventilation!
- Keep the heat sinks uncovered to ensure heat dissipation performance.

### 4.2 Location Requirements

Select an optimal mounting location for safe operation, long service life, and outstanding performance.

- The inverter with IP66 can be installed both indoors and outdoors.
- Install the inverter in a place convenient for electrical connection, operation, and maintenance.

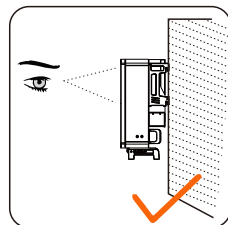
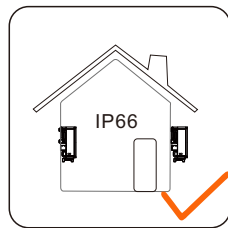

#### 4.2.1 Installation Environment Requirements

- The installation environment is free of inflammable or explosive materials.
- The location should be not accessible to children.

- The ambient temperature and relative humidity must meet the following requirements.



- Prevent the inverter from direct exposure to sun, rain and snow.
- The inverter should be well ventilated. Ensure air circulation.
- Never install the inverter in living areas. The inverter will generate noise during operation, affecting daily life.

#### 4.2.2 Carrier Requirements

The installation carrier should meet the following requirements:



Made of non-flammable materials  
Max. load bearing capacity ≥ 4 times of inverter weight

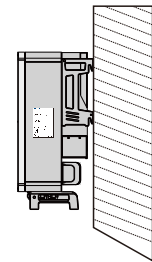

#### 4.2.3 Installation Angle Requirements

Inverter vertically . Forward installation or upside down installation is prohibited.

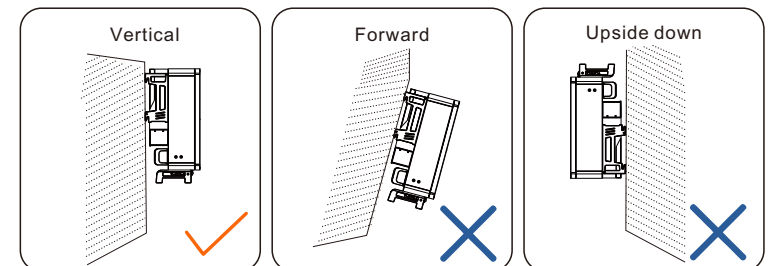

#### 4.2.4 Installation Clearance Requirements

- Reserve enough clearance around the inverter to ensure sufficient space for heat dissipation. (The fans are maintained on the left and right side of the inverter, and a larger clearance is required.)

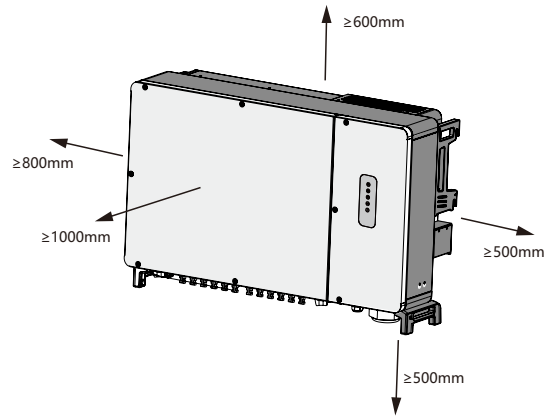

- In case of multiple inverters, reserve specific clearance between the inverters.

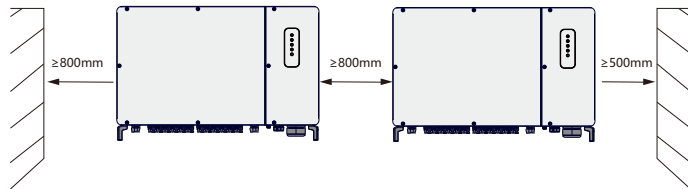

- In case of back-to-back installation, reserve specific clearance between the two inverters.

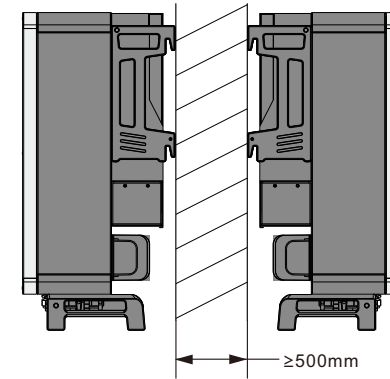

- Install the inverter at an appropriate height for ease of viewing LED indicators and operating switches.

### 4.3 Installation Tools

Installation tools include but are not limited to the following recommended ones. If necessary, use other auxiliary tools on site.



table 4-1 Tool specification

No.	Specification
a	M2/M6
b	M4/M6/M8
c	Drill bit: φ12, φ14
d	Includes sleeve with opening size 16mm
e	Opening: 13, 16mm
f	Crimp range 4~6mm <sup>2</sup>
g	Range≥1100Vdc

### 4.4 Moving the Inverter

Move the inverter to the specified position before installation. The inverter can be moved manually or via a hoist.

#### 4.4.1 Manual Transport

Use the handles on the backplane and base to transport the inverter to the destination.

#### CAUTION

Inappropriate moving operation may cause personal injury! It is recommended that at least four installers carry the inverter together and wear protective equipment such as smash-proof shoes and gloves. Always beware of the gravity center of the inverter and avoid tipping.

#### NOTICE

The ground surface on which the inverter is to be placed should be covered with a sponge pad, foam cushion or the like to prevent the inverter bottom from scratches.

#### 4.4.2 Hoisting Transport

step 1 Anchor two M10 thread lifting rings to the hangers of the inverter.

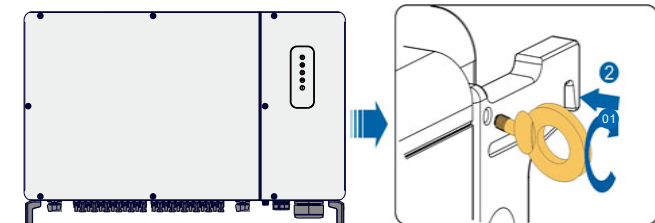

step 2 Lead the sling through the two lifting rings and fasten the tie-down strap.

step 3 Hoist the inverter, and stop to check for safety when the inverter is 100mm above the ground. Continue hoisting the device to the destination after ensuring the safety.

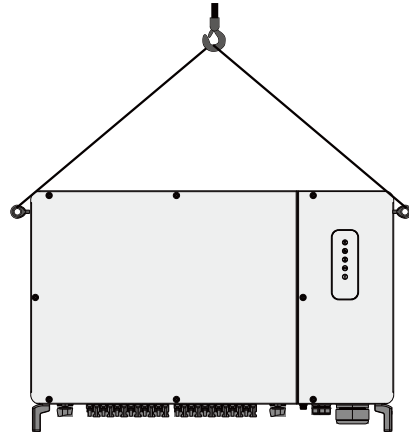

step 4 Remove the lifting rings and reassemble the sealing screws released in Step 1.

**CAUTION**

Keep the inverter balanced throughout the hoisting process and avoid collisions with walls or other objects. Stop hoisting in the event of severe weather, such as heavy rain, thick fog, or strong wind.



The lifting rings and the sling are not within the delivery scope.

-- End

### 4.5 Dimensions of mounting-bracket

Dimensions of the assembled mounting-bracket are as follows:

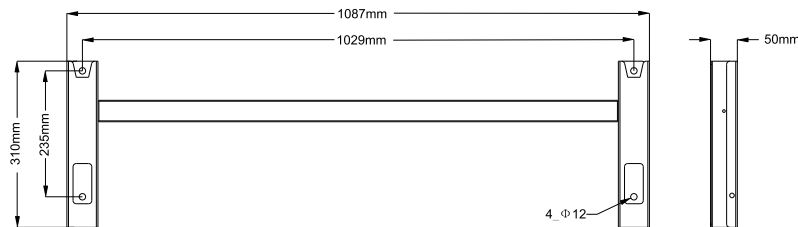

figure 4-1 Dimensions of mounting-bracket

## 4.6 PV Bracket-Mounted Installation

### 4.6.1 Preparation before Mounting

Item	Specification
Phillips screwdriver/ electric screw driver	M4, M6
Marker	-
Level	-
Hammer drill	Drill bit: φ12
Socket wrench	Including 16mm socket
wrench	Opening: 16mm

#### Spare parts

Item	Quantity	Specification	Source
Grub screw	2	M4×10	Delivery scope
	2	M6×35	Delivery scope
Bolt assembly	4	M10	Delivery scope

### 4.6.2 Mounting Steps

step 1 Assemble the mounting-bracket by using the connecting bar.

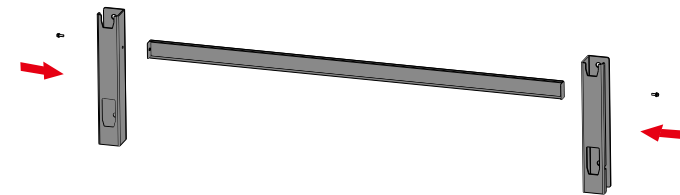

step 2 Level the assembled mounting-bracket by using the level, and mark the positions for drilling holes on the PV bracket. Drill the holes by using a hammer drill.

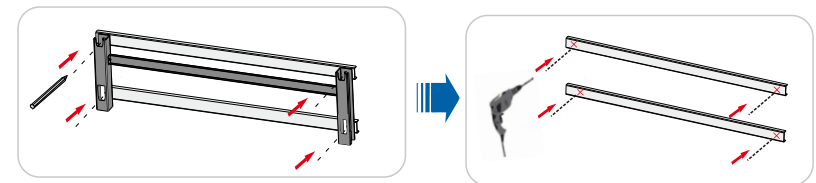



step 3 Secure the mounting-bracket with bolts.

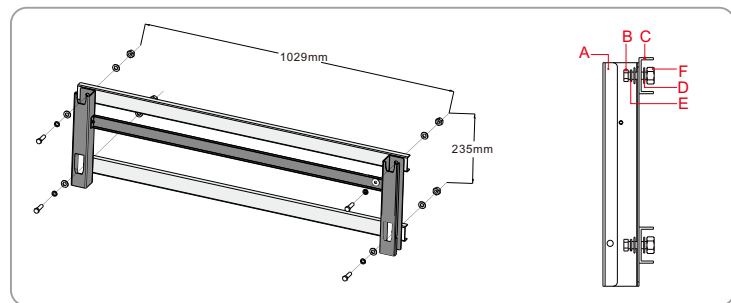

table 4-2 Fastening sequence

No.	Components	Description
A	Mounting-bracket	-
B	Full threaded bolt	M10*35
C	Metal bracket	-
D	Flat washer	-
E	Spring washer	-
F	Hex nuts	M10

step 4 Take out the inverter from the packing case.

step 5 Hoist the inverter to the installation position when necessary (refer to "4.4.1 Hoisting Transport"). If the installation position is not high enough, skip performing this step.

step 6 Hang the inverter to the mounting-bracket and ensure that the mounting ears perfectly engage with the mounting-bracket.

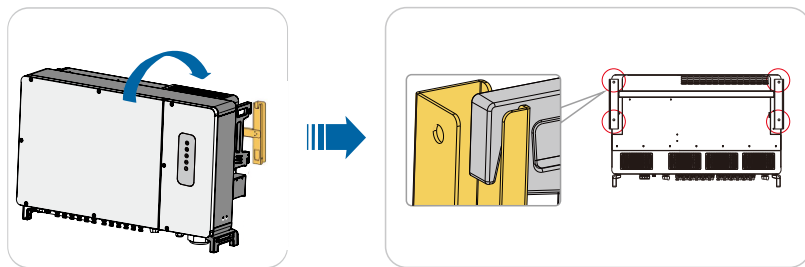

step 7 Fix the inverter with two M6×35 screws.

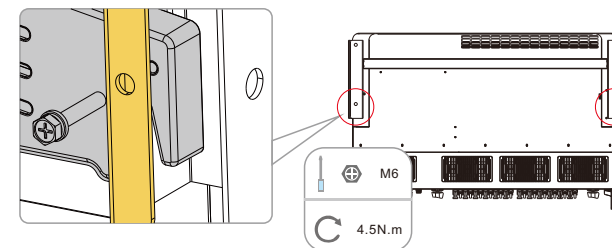

-- End

## 4.7 Wall-Mounted Installation

### 4.7.1 Preparation before Mounting

Tools

Item	Specification
Phillips screwdriver/ electric screw driver	M4, M6
Marker	-
Level	-
Hammer drill	Drill bit(Select according to expansion bolt specifications)
Socket wrench	Including 16mm socket
wrench	Opening: 16mm

Spare parts

Item	Quantity	Specification	Source
Grub screw	2	M4×10	Delivery scope
	2	M6×35	Delivery scope
Expansion bolts	4	M10×95 (Recommended)	Self-prepared

### 4.7.2 Mounting Steps

step 1 Assemble the mounting-bracket by using the connecting bar.

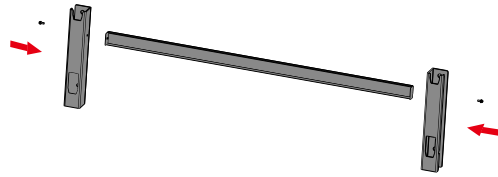

**step 2** Level the assembled mounting-bracket by using the level, and mark the positions for drilling holes on the installation site.

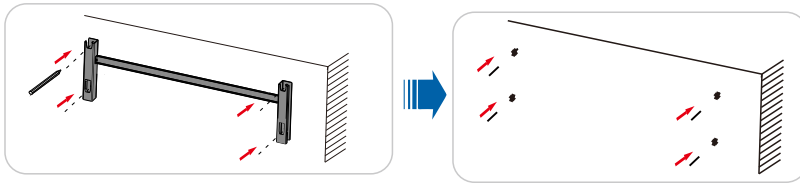

**step 3** Insert the expansion bolts into the holes and secure them with a rubber hammer. Fasten the nut with a wrench to expand the bolt. Remove the nut, spring washer, and flat washer, and store them properly.

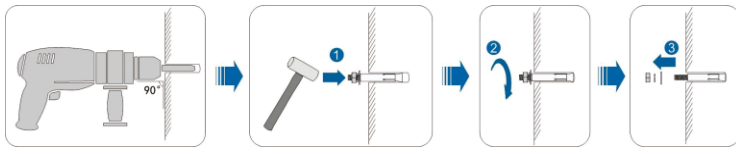

**step 4** Fix the mounting-bracket with the expansion bolts.

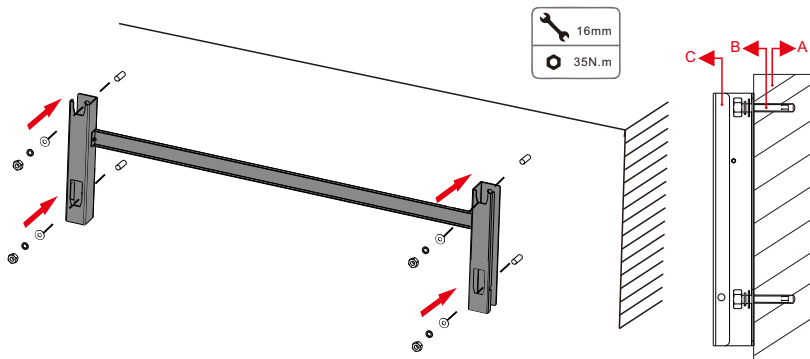

**table 4-3** Fastening sequence

Item	Designation	Description
A	Wall	-
B	Expansion bolt	Fastening the bolt in the sequence of nut, spring washer, slat washer
C	Mounting-bracket	-

**step 5** Take out the inverter from the packing case.

**step 6** Hoist the inverter to the installation position when necessary (refer to "4.4.1 Hoisting Transport"). If the installation position is not high enough, skip performing this step.

**step 7** Hang the inverter to the mounting-bracket and ensure that the mounting ears perfectly engage with the mounting-bracket.

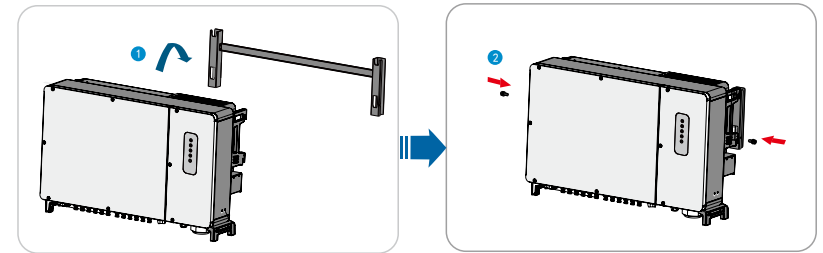

**step 8** Fix the inverter with screws.

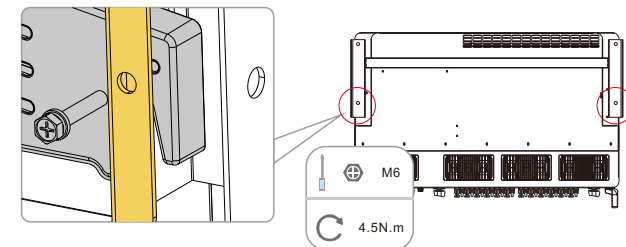

-- End

## 5 Electrical Connection

### 5.1 Safety Instructions

Prior to any electrical connections, keep in mind that the inverter has dual power supplies. It is mandatory for the qualified personnel to wear personal protective equipments (PPE) during the electrical work.

**⚠ DANGER**

**Danger to life due to a high voltage inside the inverter!**

- The PV string will generate lethal high voltage when exposed to sunlight.
- Before starting electrical connections, disconnect the DC and AC circuit breakers and prevent them from inadvertent reconnection.
- Ensure that all cables are voltage free before performing cable connection.

**⚠ WARNING**

- Any improper operations during cable connection can cause device damage or personal injury.
- Only qualified personnel can perform cable connection.
- All cables must be undamaged, firmly attached, properly insulated and adequately dimensioned.

Comply with the safety instructions related to the PV strings and the regulations related to the utility grid.

- All electrical connections must be in accordance with local and national standards.
- Only with the permission of the utility grid, the inverter can be connected to the utility grid.

### 5.2 Terminal Description

Wiring terminals are at the bottom of the inverter, as shown in the figure below.

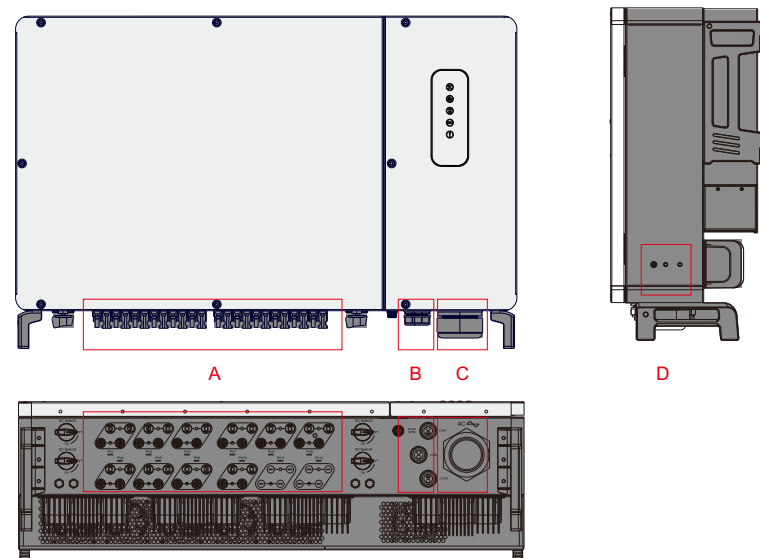

figure 5-1 Wiring terminals

\* Figure shown here is for reference only. The actual product you receive may differ !

Item	Terminal	Mark	Note
A	PV terminals	+ / -	20, PV connector(KSG-120CL-M3 is 14)
B	Communication terminal	COM1	RS485 communication.
		COM2	
		COM3	
C	AC wiring terminal	AC	Used for AC output cable connection.
D	Additional grounding terminal		two ground shall be connected.

### 5.3 Electrical Connection Overview

Electrical connection in the PV system includes additional grounding connection, AC connection, and PV string connection.

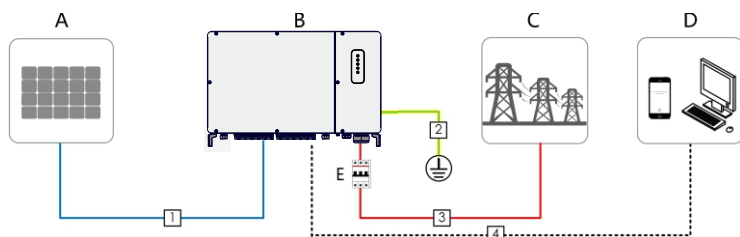

Item	Designation
A	PV string
B	Inverter
C	Grid
D	Monitoring device
E	AC circuit breaker

table 5-1 Cable requirements

No.	Cable	Type	Specification	
			Cable Diameter (mm)	Cross-sectional area (mm <sup>2</sup> )
1	DC cable	PV cable complying with 1100V standard	6~8	4~6
2	Additional Grounding cable	Outdoor single-core copper wire cable	/	The same as that of the PE wire in the AC cable
3	AC cable	Four (or five) core copper or aluminum cable*	38~56	L1,L2,L3,PE(N) wire:70~95
4	Communication cable	Shielded twisted pair	5~8	1~1.5

\* A copper to aluminum adapter terminal is required when an aluminum cable is used. For details, refer to "5.6.3 Aluminium Cable Requirements".

table 5-2 PE wire requirements

PE wire cross section	Note
S/2 (S: Phase wire cross-section S)	The specifications are valid only when the phase wire and PE wire use the same material. If otherwise, ensure that the cross section of the PE wire produces a conductance equivalent to that of the wire specified in the table.

### 5.4 Additional Grounding Connection

#### ⚠ WARNING

Since the inverter is a transformerless inverter, neither the negative pole nor the positive pole of the PV string can be grounded. Otherwise, the inverter will not operate normally. Connect the additional grounding terminal to the protective grounding point before AC cable connection, PV cable connection, and communication cable connection. The ground connection of this additional grounding terminal cannot replace the connection of the PE terminal of the AC cable. Make sure thoes terminals are both grounded reliably.

#### 5.4.1 Additional Grounding Requirements

All non-current carrying metal parts and device enclosures in the PV power system should be grounded, for example, brackets of PV modules and inverter enclosure. When there is only one inverter in the PV system, connect the additional grounding cable to a nearby grounding point.

When there are multiple inverters in the PV system, connect grounding points of all inverters and the PV array frames to the equipotential cable (according to the onsite conditions) to implement an equipotential connection.

#### 5.4.2 Connection Procedure

step 1 Prepare the cable and terminal.

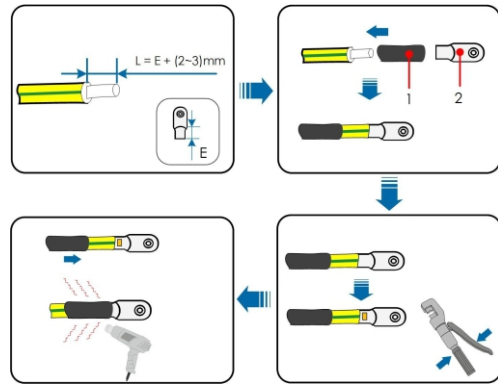

1:Heat shrink tubing

2:terminal(M6)

step 2 Remove the screw on the grounding terminal and fasten the cable with a screwdriver.

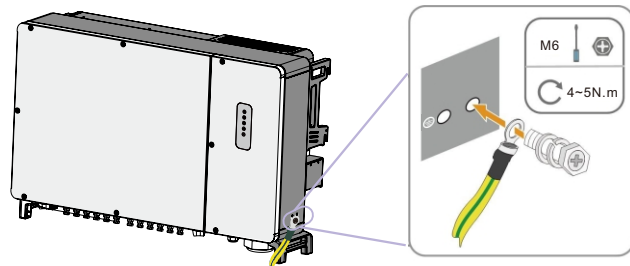

step 3 Apply paint to the grounding terminal to ensure corrosion resistance.

-- End



The grounding screws have been anchored to the side of the inverter before delivery, and do not need to be prepared. There are two grounding terminals. Use at least one of them to ground the inverter.

### 5.5 Opening the Wiring Compartment

step 1 Release three screws on the front cover of the wiring compartment with supplied wrench.

step 2 Open the wiring compartment.

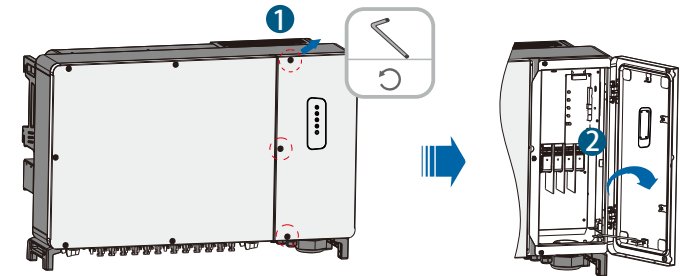

step 3 Keep the wiring compartment opened during wiring through the limit lever attached to the cover.

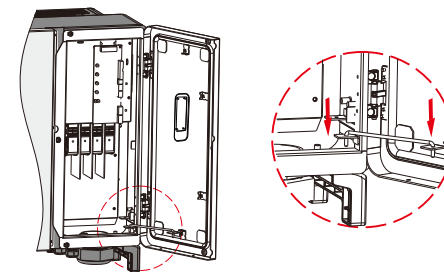

-- End



Close the wiring compartment in reverse order after completing wiring operations.

## 5.6 AC Cable Connection

### 5.6.1 AC Side Requirements

Before connecting the inverter to the grid, ensure the grid voltage and frequency comply with requirements, for which, refer to "10.1 Technical Data". Otherwise, contact the electric power company for help.



Connect the inverter to the grid only after getting an approval from the local electric power company.

#### AC Circuit Breaker

An independent three-pole circuit breaker is installed on the output side of the inverter to ensure safe disconnection from the grid.

Inverter	Recommended rated voltage	Recommended rated current
KSG-120CL-M0/M3	400V	250A

If multiple inverters need to share a circuit breaker, the circuit breaker should be selected according to the capacity.

#### NOTICE

**Never connect a load between the inverter and the circuit breaker.**

#### Multiple Inverters in parallel Connection

If multiple inverters are connected in parallel to the grid, ensure that the total number of parallel inverters does not exceed 28. Otherwise, please contact KSTAR for technical scheme.

#### MV transformer

The MV transformer used together with the inverter should meet the following requirements:

- The transformer may be a distribution transformer, and it must be designed for the typical cyclical loads of a PV system (load in the day and no load at night).
- The transformer may be of the liquid-immersed type or dry type, and shield winding is not necessary.

- The line-to-line voltage on the LV side of the transformer should endure the output voltage of inverter. When the transformer is connected to the IT grid, to-ground withstanding voltage of the LV winding of the transformer, the AC cables, and the secondary equipment (including the relay protection device, detection & measuring device, and other related auxiliary devices) should not be lower than 1,100V.
- The line-to-line voltage on the HV side of transformer should comply with local power grid voltage.
- A transformer with a tap changer on the HV side is recommended in order to keep consistent with the grid voltage.
- At an ambient temperature of 45°C, the transformer can run in 1.1 times of load for long time.
- Transformer with a short-circuit impedance 6% (permissible tolerance: ±10%) is recommended.
- The voltage drop of system cable is no more than 3%.
- The DC component that the transformer can withstand is 1% of the fundamental current at rated power.
- For thermal rating, the load curve of the transformer and environment conditions should be taken into account.
- The apparent power of the inverter should never exceed the power of the transformer. The maximum AC current of all inverters connected in parallel must be taken into account. If more than 28 inverters are connected to the grid, contact KSTAR.
- The transformer must be protected against overloading and short circuit.
  - The transformer is an important part of grid-connected PV generation system. The fault tolerance capacity of the transformer should be taken into account at all times. The fault include: system short circuit, grounding fault, voltage drop, etc.
  - Take ambient temperature, relative humidity, altitude, air quality, and other environmental conditions into account when selecting and installing the transformer.
  - When the anti-PID function is enabled, observe the following items:
    - If the LV side winding is in Y shape, neutral point grounding is prohibited.
    - Surge protective devices (SPD) for the AC combiner box and on the LV side of the transformer are recommended to be connected in the "3 +1" manner, as shown in the figure below. The Min. continuous operating voltages of M1-M4 are 750VAC.
    - The LV side winding of the transformer, AC cables, and secondary devices (- including protective relay, detection and measurement instruments, and related auxiliary devices) must withstand the voltage to ground of at least 906V.

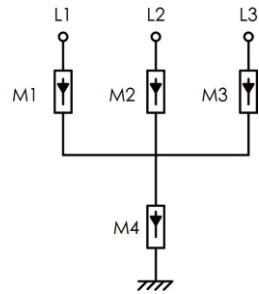

**5.6.2 Requirements for OT/DT Terminal**

The factory default standard SC-75 terminal, if customers need to use OT/DT terminal, they need to purchase according to the following requirements.

- Specification: M10;
- Dimensions:  $a \leq 28\text{mm}$  /  $b \geq 10.5\text{mm}$  /  $c \leq 16\text{mm}$ .

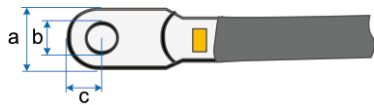

figure 5-2 Dimensions of Terminal

**5.6.3 Aluminium Cable Requirements**

If an aluminium cable is selected, use a copper to aluminium adapter terminal to avoid direct contact between the copper bar and the aluminium cable.

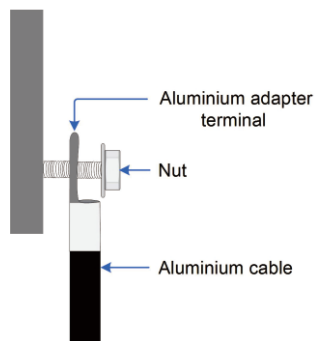

figure 5-3 Aluminium cable terminal connection sequence

**NOTICE**

Ensure that the selected terminal can directly contact with the copper bar. If there are any problems, contact the manufacturer of terminal. Direct contact between the copper bar and the aluminium cable will cause electrochemical corrosion and impair the reliability of electrical connection.

**5.6.4 Connection Procedure**



In this manual, description is given by using five-core cable as an example. The wiring method of the four-core cable is the same.

- step 1** Open the wiring compartment. For details, refer to "5.5 Opening the Wiring Compartment".
- step 2** Disconnect the AC-side circuit breaker and prevent it from inadvertent reconnection.
- step 3** Loosen the swivel nut of the AC waterproof connector and select a seal according to the cable outer diameter. Lead the cable through the swivel nut, seal, and wiring terminal successively.

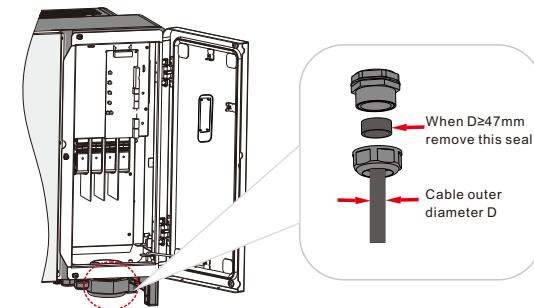

step 4 Strip the protection layer and insulation layer by specific length, as described in the figure below.

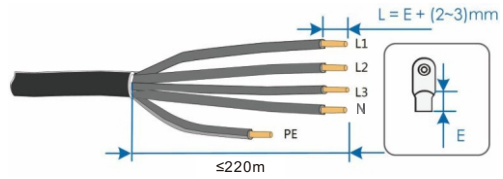

step 5 Make the cable and crimp terminal.

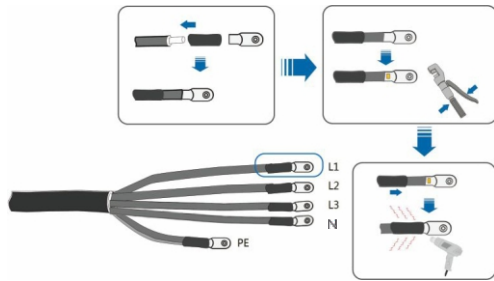

step 6 Secure the wires to corresponding terminals.

**NOTICE**

Note the terminal positions of PE wire and N wire. If a phase wire is connected to the PE terminal or N terminal, unrecoverable damage may be caused to the inverter.

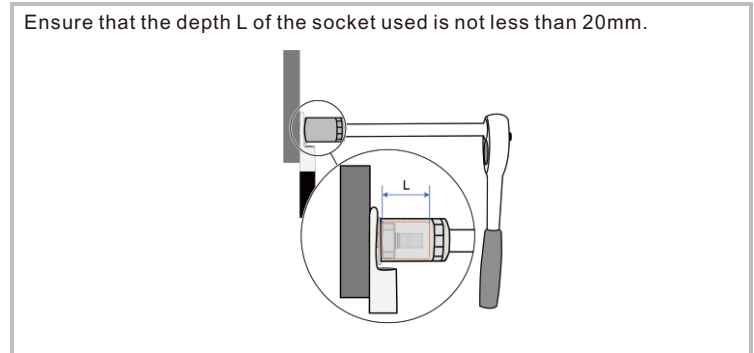
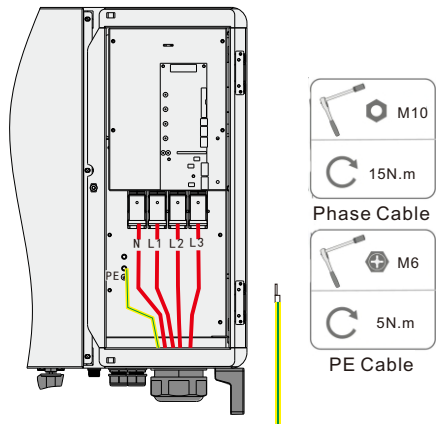

step 7 Gently pull the cable backwards to ensure firm connection, and fasten the swivel nut clockwise.

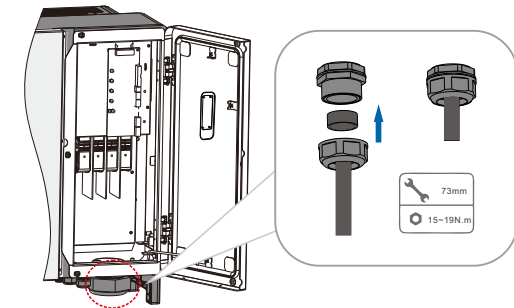

-- End



### 5.7 DC Cable Connection

**⚠ DANGER**

**Electric shock!**  
The PV array will generate lethal high voltage once exposed to sunlight.

**⚠ CAUTION**

Make sure the PV array is well insulated to ground before connecting it to the inverter.

**NOTICE**

There is a risk of inverter damage! The following requirements should be met. Failure to do so will void guarantee and warranty claims.

- Make sure the maximum voltage of each string is always less than 1100V.
- Make sure the maximum short circuit current on the DC side is within the permissible range.

#### 5.7.1 PV Input Configuration

As shown in the figure below, the inverter is provided with multiple PV inputs: PV inputs 1~10; and each PV input is designed with an MPP tracker.

Each PV input operates independently and has its own MPPT. In this way, string structures of each PV input may differ from each other, including PV module type, number of PV modules in each string, angle of tilt, and installation orientation.

Each PV input area includes two DC inputs DC1 and DC2. For the best use of DC power, DC1 and DC2 should be the same in PV string structure, including the type, number, tilt, and orientation of the PV modules.

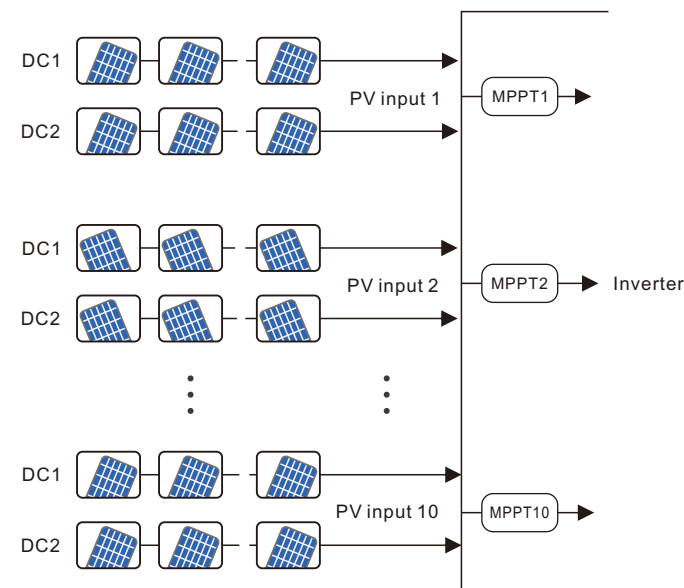

Type	Open circuit voltage limit	Max. current for input connector
KSG-120CL-M0/M3	1100V	32A

#### 5.7.2 Connection Procedure

KSTAR provides corresponding plug connectors in the scope of delivery for quick connection of PV inputs.

DC cables should be connected to the inverter via PV connectors which are included in the scope of delivery.



To ensure IP66 protection, use only the supplied connector or the connector with the same ingress of protection.

**⚠ DANGER**

**High voltage may be present in the inverter!**

- Ensure all cables are voltage-free before performing electrical operations.
- Do not connect the AC circuit breaker before finishing electrical connection.

**NOTICE**

Use the UTX DC terminal within the scope of delivery. Damage to the device due to the use of incompatible terminal shall not be covered by the warranty.

step 1 Strip the insulation from each DC cable by 7mm.

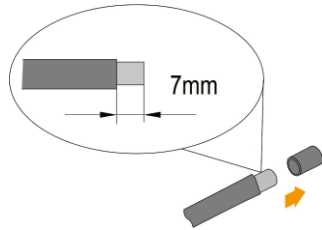

step 2 Assemble the cable ends with the crimping pliers.

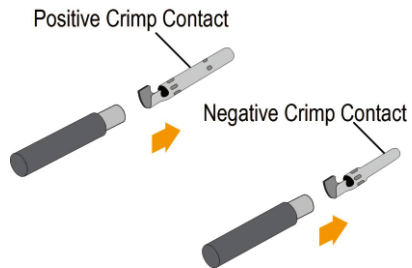

step 3 Lead the cable through cable gland, and insert into the insulator until it snaps into place. Gently pull the cable backward to ensure firm connection. Tighten the cable gland and the insulator (torque 2.5 N.m to 3 N.m).

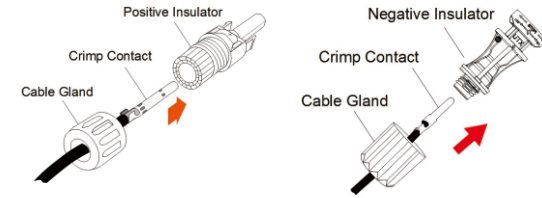

step 4 Check for polarity correctness.

**NOTICE**

The inverter will not function properly if any PV polarity is reversed.

-- End

**5.7.3 Installing the PV Connectors**

step 1 Rotate all the DC switches to "OFF" position.

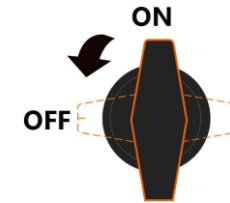

Skip performing step1 when the actual device is not equipped with DC switches.

step 2 Check the cable connection of the PV string for polarity correctness and ensure that the open circuit voltage in any case does not exceed the inverter input limit of 1100V.

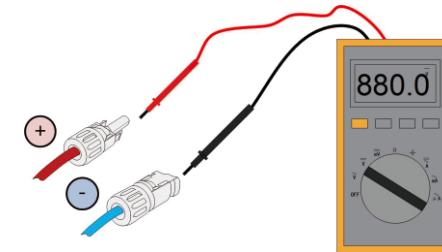

step 3 Connect the PV connectors to corresponding terminals until there is an audible click.

**NOTICE**

Check the positive and negative polarity of the PV strings, and connect the PV connectors to corresponding terminals only after ensuring polarity correctness.

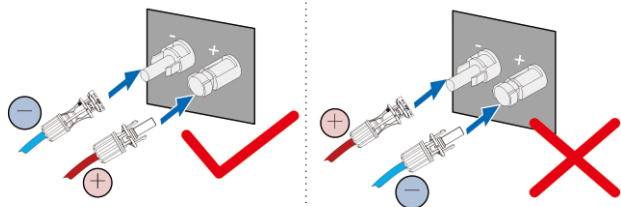

Arc or contactor over temperature may occur if the PV connectors are not firmly in place, and KSTAR shall not be held liable for any damage caused.

step 4 Follow the foregoing steps to connect PV connectors of other PV strings.

step 5 Seal the unused PV terminals with the terminal caps.

-- End

**5.8 RS485 Communication**

**5.8.1 Interface Description**

The following figure shows the position of the communication wiring board in the inverter as well as the terminals equipped for the wiring board. herwise, skip performing this step.

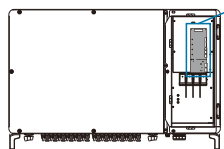
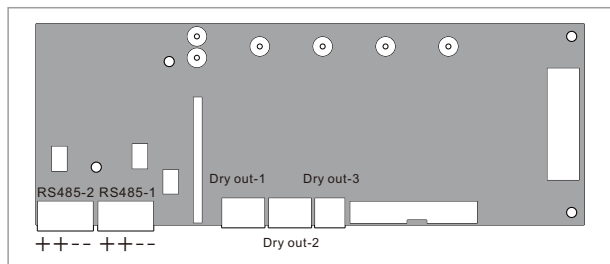

**5.8.2 RS485 Communication System**  
**Single-inverter communication system**

In case of a single inverter, communication cable connection requires only one RS485 cable.

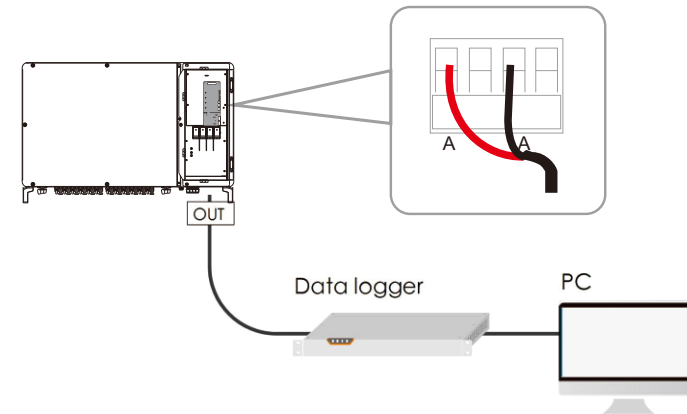

**Multi-inverter communication system**

In case of multiple inverters, all the inverters can be connected via RS485 cables in the daisy chain manner.

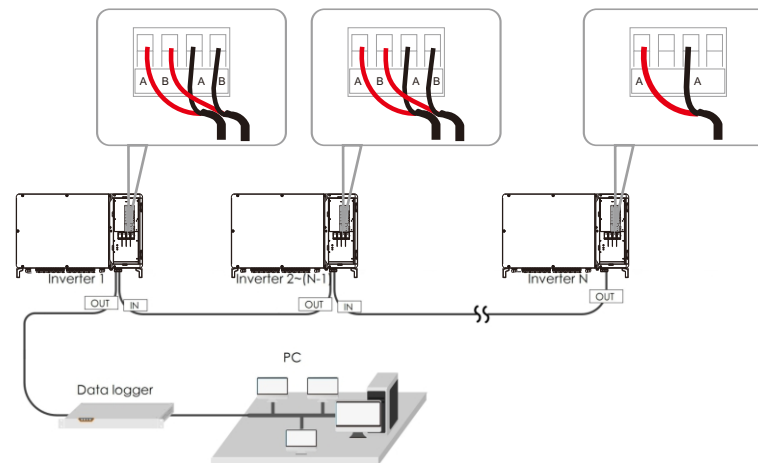

### 5.8.3 Connection Procedure(Terminal Block)

RS485 communication cables should be shielded twisted pair cables or shielded twisted pair Ethernet cables.



There are three RS485 communication terminals COM1, COM2, COM3 on the bottom of the inverter. Please choose according to the actual situation.

step 1 Strip the protection layer and insulation layer by appropriate length.

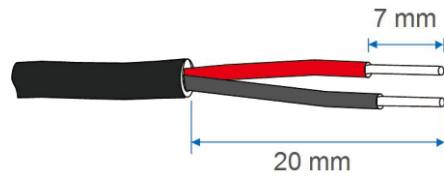

step 2 Loosen the swivel nut of the communication terminal and select an appropriate seal according to cable outer diameter. Lead the cable through the swivel nut and seal successively.

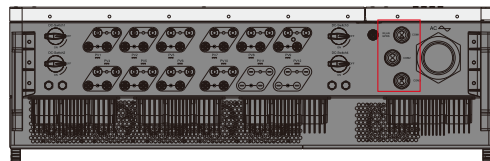
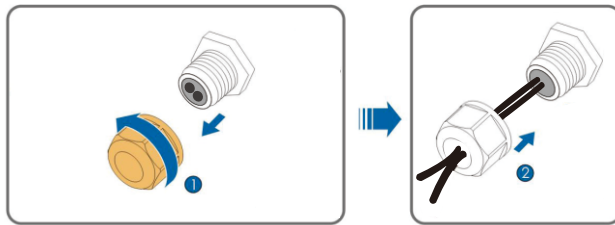

Outer diameter D(mm)	Seal
5~8	a

step 3 Secure the cable to the terminal base.

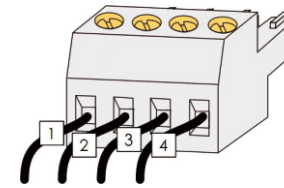

step 4 Insert the terminal base into the corresponding terminal.

table 5-4 RS485\_1 Terminal definition

No	Definition
1	RS485 A IN, RS485A differential signal+
2	RS485 B IN, RS485B differential signal+
3	RS485 A OUT, RS485A communication signal-
4	RS485 B OUT, RS485B communication signal-

step 5 Pull the cable gently to make sure it is secured, tighten the swivel nut clockwise.

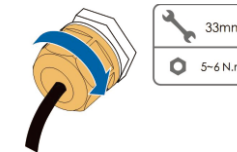

-- End

## 5.9 PLC Communication Connection

With a PLC communication module built inside, the inverter can communicate with the Photovoltaic communication box provided by KSTAR. For specific wiring method, refer to the photovoltaic communication box user manual.



- The photovoltaic communication box is an optional device that can be ordered from KSTAR.
- The photovoltaic communication box conducts data communication by directly using the AC output cable of the inverter and thus saves the trouble to lay and maintain the special communication cables. The RS-485 port of the photovoltaic communication box supports the transparent transmission of the MODBUS-RTU and is completely compatible with the monitoring devices and software of the original RS-485 communication method.

## 5.10 Closing the Wiring Compartment

step 1 Release the limit lever.

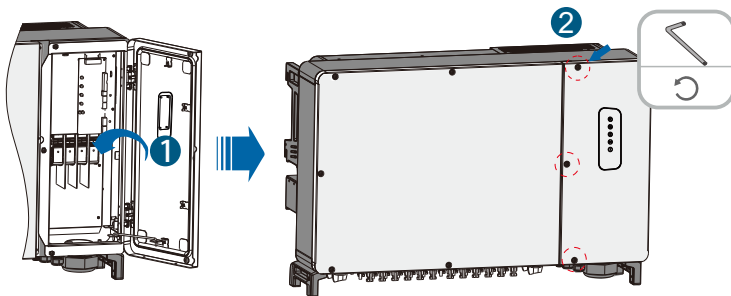

-- End

## 6. Commissioning

### 6.1 Inspection before Commissioning

Check the following items before starting the inverter:

- The inverter DC switch and external circuit breaker are disconnected.
- The inverter should be accessible for operation, maintenance and service.
- Nothing is left on the top of the inverter.
- The inverter is correctly connected to the external devices, and the cables are routed in a safe place or protected against mechanical damage.
- The selection of the AC circuit breaker is in accordance with this manual and all applicable local standards.
- All unused terminals at the bottom of the inverter are properly sealed.
- Warning signs & labels are suitably affixed and durable.

### 6.2 Commissioning Procedure

If all of the items mentioned above meet the requirements, proceed as follows to start up the inverter for the first time.

step 1 Rotate the DC switch of the inverter to "ON" position.



Skip performing step1 when the actual device is not equipped with DC switches.

step 2 Connect the AC switch (if applicable) between the inverter and the grid.

step 3 Connect the DC switch (if applicable) between the inverter and the PV string.

step 4 Set initial protection parameters via the Ksolar APP. For details, please refer to "7.4.2 Login Steps". If the irradiation and grid conditions meet requirements, the inverter will normally operate.

step 5 Observe the LED indicator to ensure that the inverter operates normally. (Refer to Tab2.2.4 LED indicator description).

-- End

## 7. Bluetooth APP Settings

### 7.1 Overview

The bluetooth function relies on the Kstar photovoltaic APP to send information to the Internet via bluetooth for data monitoring of KSG series inverters. Users can connect to bluetooth to query the data information of inverters and set up the collection equipment.

### 7.2 APP download



Android



Apple iOS

### 7.3 Bluetooth connection (need to enter into the login interface of Kstar photovoltaic APP)

- ①. After scanning the code to download the photovoltaic APP, the user opens the APP and enters the login interface in Figure 10;
- ②. Click the icon of "bluetooth connection" on the login page to enter the bluetooth matching page in Figure 11, and click "start pairing" (Remark: when android user does not manually open bluetooth, it will automatically detect and prompt the user to open mobile phone bluetooth or not; or the user can manually open mobile phone bluetooth before connection, and then it will not prompt to connect directly; there is no prompt message for apple users, so they need to manually turn on the phone's bluetooth in advance, that is, open the physical bluetooth key);
- ③. After pairing, it enters the interface in Figure 12, and the page will automatically search for the bluetooth that can be matched and display the name of the bluetooth that can be connected. If the search fails of android phone page, click the refresh icon in the upper right corner to search again. The iphone automatically searches directly.

- ④. Click the name of bluetooth in the list and connect bluetooth, and it enters the interface in Figure 13 after successful connection. This page will display the basic information of the device, and users can view and set the information by clicking the icons of query, settings and statistics on this page.

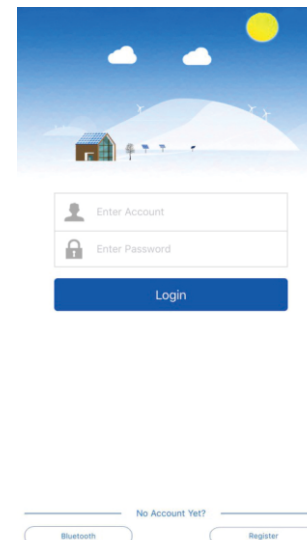

Fig.10

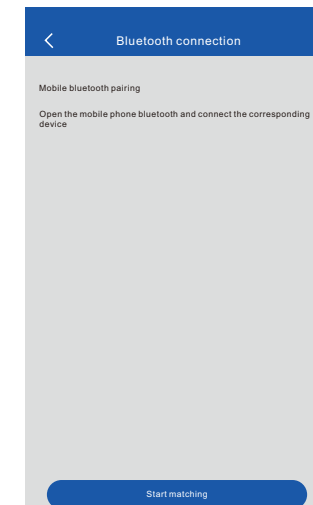

Fig.11

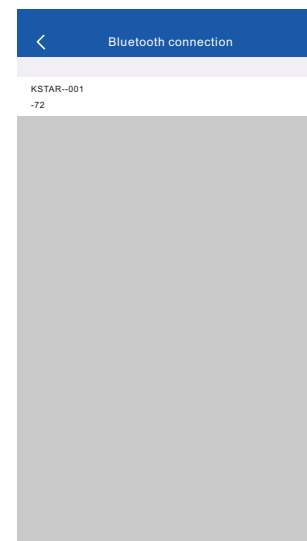

Fig.12

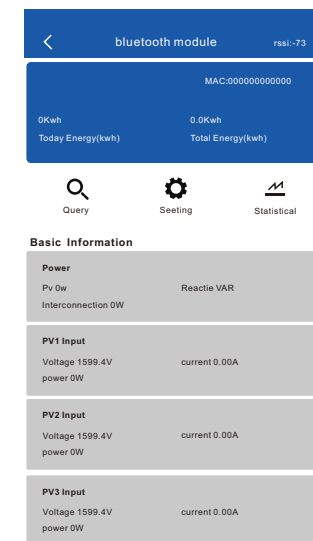

Fig.13

### 7.4 Basic information interface

①. After it enters the bluetooth connection page, the interface will monitor the input information of each PV, and the real-time data will be continuously refreshed for the input information of the device:

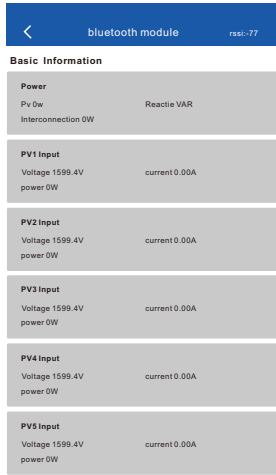

Fig.14

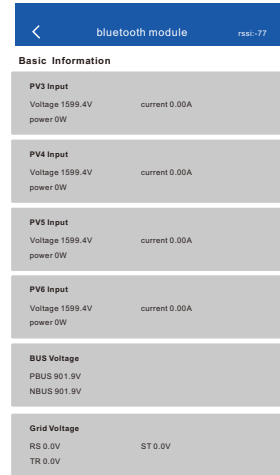

Fig.15

- ② . Inverter power and voltage as well as power grid information:
- ③ . Equipment temperature, operating mode and error alarm information:

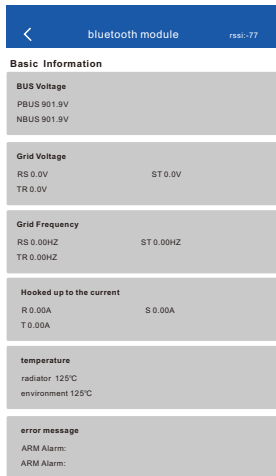

Fig.16

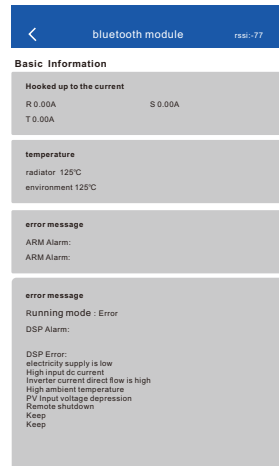

Fig.17

### 7.5 Query interface

After entering the bluetooth connection page, click the "query" icon, and the page will display the inverter machine model and version information, as well as the running record and error event details (click "details" on the error page to view detailed data).

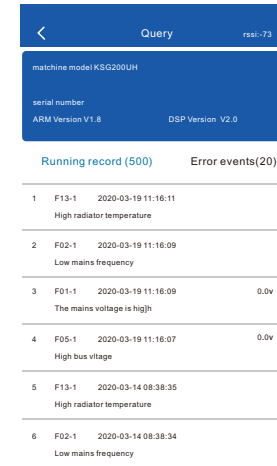

Fig.18

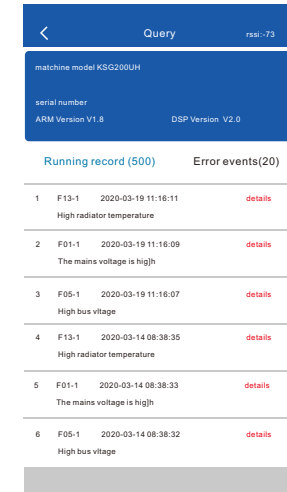

Fig.19

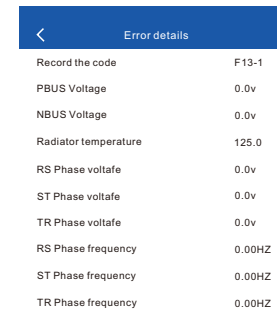

Fig.20

### 7.6 Query interface

After entering the bluetooth connection page, click the "settings" icon, enter the page to manually refresh the data for remote switch operation, record clearing operation and clock setting; the inverter power, voltage, input mode, protocol and other information can be customized for setting, and machine self-detection setting can also be conducted.

Note: to enter the settings page, you need to enter the first-class password (default: 00000).

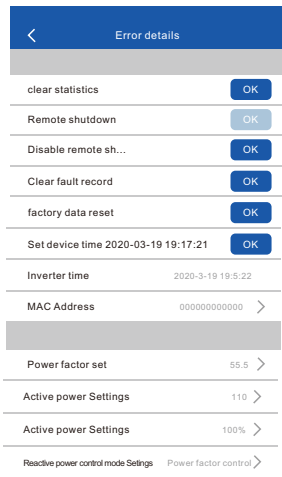

Fig.21

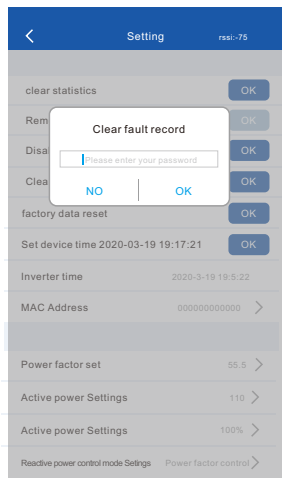

Fig.22

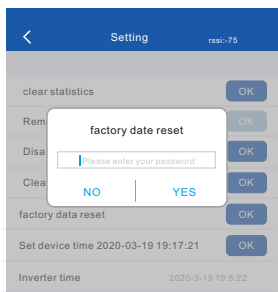

Fig.23

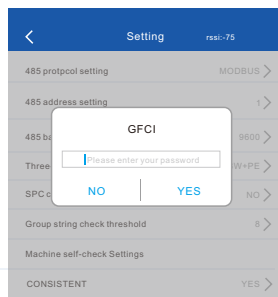

Fig.24

7.6.1 Set page information:

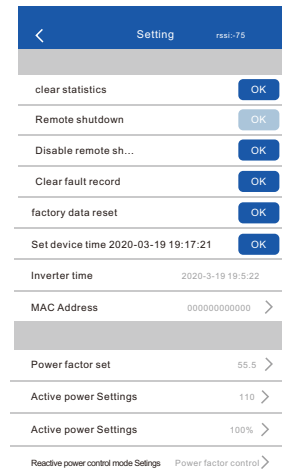

Fig.25

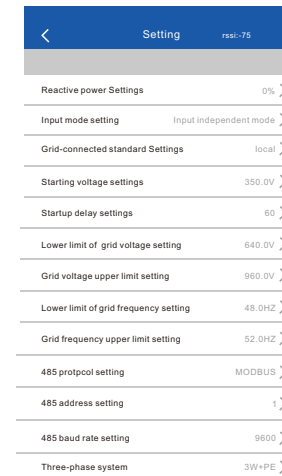

Fig.26

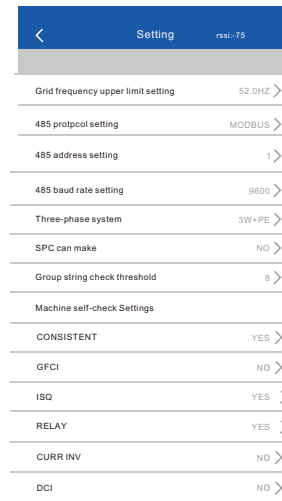

Fig.27

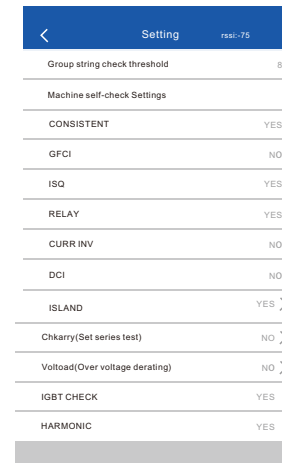

Fig.28



7.6.2 Related parameters setting interface:

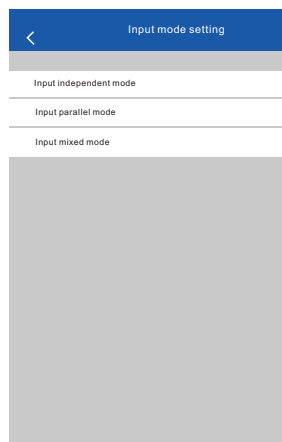

Fig.29



Fig.30

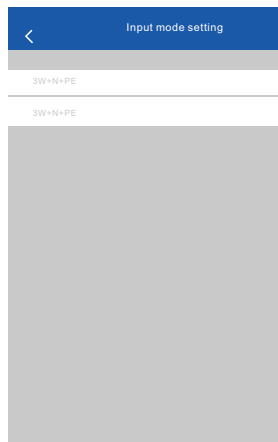

Fig.31

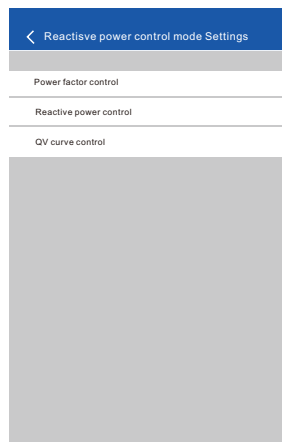

Fig.32

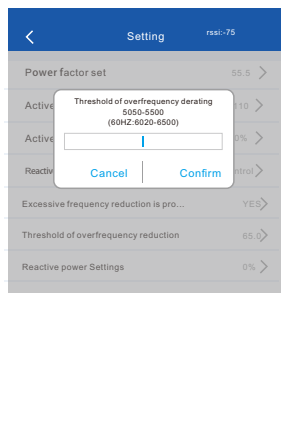

Fig.33

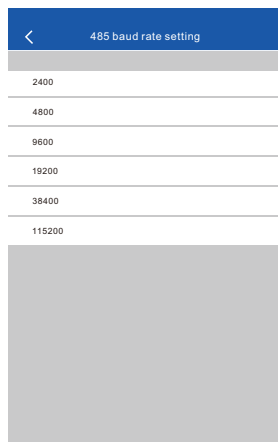

Fig.34

7.6.3 Set parameter information:

a. Input mode information:

No.	Content	Input mode
0	00H	Input independent mode
1	01H	Input parallel mode
2	02H	Input mixed mode

Note: only independent mode can be input above 100k!

b. Setting information of grid-connection standards, voltage upper and lower limits and grid frequency upper and lower limits:

07H~3CH and 3EH(1100V Inverter 400VAC)						
No.	Content	Grid-connection standards	Lower voltage limit	Upper voltage limit	Lower frequency limit	Upper frequency limit
0	00H	China	LN:195.5-220 LL:340-390	LN:230-276 LL:410-480	48-49.8	50.2-50.5
1	01H	German	LN:196-220 LL:340-390	LN:240-264 LL:410-460	47.5-49.8	50.2-51.5
2	02H	Australia	LN:200-220 LL:340-390	LN:240-270 LL:410-480	48-49.8	50.2-52
3	03H	Italy	LN:184-220 LL:320-390	LN:240-276 LL:410-480	49.7-49.8	50.2-50.3
4	04H	Spain	LN:196-220 LL:340-390	LN:240-253 LL:410-440	48-49.8	50.2-50.5
5	05H	Britain	LN:184-220 LL:320-390	LN:240-264 LL:410-460	47-49.8	50.2-52
6	06H	Hungary	LN:196-220 LL:360-390	LN:240-253 LL:410-440	49-49.8	50.2-51
7	07H	Belgium	LN:184-220 LL:320-390	LN:240-264 LL:410-460	47.25-49.8	50.2-51.5
8	08H	Western Australia	LN:200-220 LL:340-390	LN:240-270 LL:410-480	47.5-49.8	50.2-50.5
9	09H	Greece	LN:184-220 LL:320-390	LN:240-264 LL:410-460	49.5-49.8	50.2-50.5
10	0AH	France	LN:184-220 LL:320-390	LN:240-264 LL:410-460	47.5-49.8	50.2-50.4
11	0BH	Bangkok	LN:200-220 LL:320-390	LN:230-264 LL:390-480	49-49.8	50.2-51
12	0CH	Thailand	LN:176-220 LL:320-390	LN:230-264 LL:390-480	47-49.8	50.2-52
13	0DH	Plant	LN:184-220 LL:320-390	LN:240-276 LL:410-480	48-49.8	50.2-52
14	0EH	Local	LN:150-220 LL:260-390	LN:240-290 LL:410-502	45-49.8	50.2-55
15	0FH	60 Hz	LN:184-220 LL:320-390	LN:240-276 LL:410-480	58-59.8	60.2-62

Remark: the corresponding mode of LL is 3W+PE; the corresponding mode of LN is 3W+N+PE.

**c. Power factor setting:**

Value range	Meaning explanation
00800-01000	Reactive power is negative, and the power factor is 0.8-1
10800-11000	Reactive power is positive, and the power factor is 0.8-1
0xFFFF	Cancel power factor control (default power factor is 1)

**d. Active power setting:**

	Value range	Meaning explanation
Power percentage regulation (%)	0-100	Limit the maximum power percentage
Power value regulation (kW)	Value range 0-Pmax	Limit the maximum power value

**e. Setting of reactive power:**

Value range	Meaning explanation
-60~+60	Set the percentage of reactive power

**f. Setting of reactive power control mode:**

Value	Meaning explanation
0	Control by power factor
1	Control by reactive power
2	Control according to QV curve

**g. Threshold of over-frequency reduction:**

Value range	Meaning explanation
5020-5500 (60HZ standard: 6020-6500)	1. When the city power frequency reaches this frequency threshold, the current power of the inverter will be locked, and this power is P <sub>frozen</sub> .
	2. If the city power frequency exceeds this threshold, the power will decrease by 40%*P <sub>frozen</sub> /HZ.

**Remark:** when the standard screening for grid connection is 60Hz (South Korea), the value range is 6020-6500.

**h. Open voltage setting and delay setting:**

Setting item	Range
Power on voltage	250-900V
Power on delay	20-300S

**i. 485 protocol setting:**

Value	Protocol
0	FACTORY
1	MODBUS

**Remark:** the FACTORY protocol is not currently in use.

**j. 485 baud rate:**

Value	Baud rate
0	2400
1	4800
2	9600
3	19200
4	38400
5	115200

**k. Three-phase standard mode:**

Value	Meaning
0	3W+N+PE
1	3W+PE

I. Machine self-detection setting:

Bit	Meaning	0	1
0	CONSISTENT	Enable	Prohibit
1	GFCI		
2	ISO		
3	RELAY		
4	CURR INV		
5	DCI		
6	ISLAND		
7	ChkArray (group array detection)		
8	VoltLoad (over-voltage reduction amount)		
9	IGBT CHECK		
10	HARMONIC		

7.7 Statistics interface

This page shows the running and grid-connection time of the equipment, and monitors the power peak, and shows the days, weeks, months, years and total power generation of the inverter.

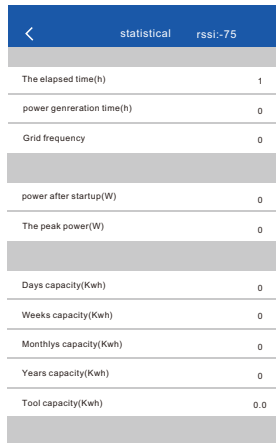

Fig.35

8 System Decommissioning

8.1 Disconnecting the Inverter

**step 1** For maintenance or other service work, the inverter must be switched off. Proceed as follows to disconnect the inverter from the AC and DC power sources. Lethal voltages or damage to the inverter will follow if otherwise.

**step 2** Rotate the DC switch to the "OFF" position for disconnecting all of the PV string inputs.

**i** Skip performing step 2 when the actual device is not equipped with DC switches.

**step 3** Wait about 5 minutes until the capacitors inside the inverter completely discharge.

**step 4** Ensure that the DC cable is current-free via a current clamp.

**step 5** Insert a MC4 wrench into the notch and press the wrench with an appropriate force to remove the DC connector.

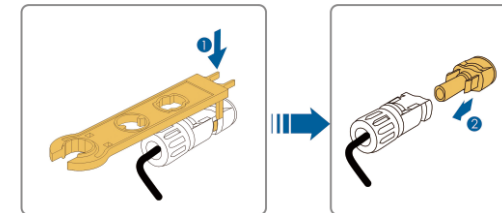

**step 6** Remove the AC junction box, ensure that the AC wiring terminals are voltage-free via a multimeter, and remove the AC wires.

**step 7** Install the MC4 waterproof plugs and AC waterproof cover.

**i** For further disconnection and reconnection instructions, please visit the webpage of respective component manufacturer.

-- End

## 8.2 Dismantling the Inverter

**⚠ CAUTION**

**Risk of burn injuries and electric shock!**

- **Do not touch any inner live parts until at least 5 minutes after disconnecting the inverter from the utility grid and the PV input.**

step 1 Refer to "5 Electrical Connection"for the inverter disconnection of all cables in reverse steps.

step 2 Dismantle the inverter referring to "4 Mechanical Mounting"in reverse steps.

step 3 If necessary, remove the wall-mounting bracket from the wall.

step 4 If the inverter will be reinstalled in the future, please refer to "3.4 Inverter Storage"for a proper conservation.

-- End

## 8.3 Disposal of the Inverter

Users take the responsibility for the disposal of the inverter.

**NOTICE**

**Some parts and devices of the inverter, such as the capacitors, may cause environmental pollution.**

**Do not dispose of the product together with household waste but in accordance with the disposal regulations for electronic waste applicable at the installation site.**

# 9 Troubleshooting and Maintenance

## 9.1 Error and alarm

Error and alarm information of photovoltaic grid-connected inverter is shown in the following table: ( the error and alarm information can be viewed from the buetooth App )

Table 9.1 Error message prompt

System faulty display		
AC Voltage Low	F00-1	AC Voltage is too low.
AC Voltage High	F01-1	AC Voltage is too high.
AC Frequency Low	F02-1	AC frequency is too low.
AC Frequency High	F03-1	AC frequency is too high.
Bus Voltage Low	F04-1	Bus voltage is too low.
Bus Voltage High	F05-1	Bus voltage is too high.
Bus Voltage Abnormal	F06-1	Positive voltage or negative voltage is too high or too low on bus.
Insulation Impedance Low	F07-1	PV arrays Insulation impedance is too low.
Input current high	F08-1	PV Input current is too high.
Hardware Current High	F09-1	Inverter current is too high.
Inverter Current High	F10-1	Inverter current is too high.
Inverter DC Current High	F11-1	Inverter DC current is too high.
Ambient Temperature High	F12-1	Ambient emperature is too high.
Heatsink Temperature High	F13-1	Heatsink temperature is too high.
AC Relay Abnormal	F14-1	AC relay is abnormal.
PV Input Voltage Low	F15-1	One of PV input is idle when inverter is set on parallel mode.
Remote OFF	F16-1	Status of inverter is on remote off.
SPI Communication Fault	F18-1	Communication fault on control
Reserved	F19-1	Reserved
Leakage Current High	F20-1	Leakage current is too high.
Self-Checking Failure Of Leakage Current	F21-1	Self -checking Failure of Leakage Current.
Consistency Voltage Fault	F22-1	Inconsistent voltage between primary CPU and secondary CPU.
Consistency Frequency Fault	F23-1	Inconsistent frequency between primary CPU and secondary CPU.
Loss of auxiliary power supply	F25-1	Auxiliary power loss, machine protection
IGBT Fault	F26-1	IGBT Fault, machine protection
DSP Communication Lost	F32-1	DSP communication faulty on

Table 9.2 Alarm information

Alarm information	Alarm code	Alarm analysis
Low speed of fan group 1	W00-1	Machine alarm due to low speed of fan group 1
Low speed of fan group 2	W01-1	Machine alarm due to low speed of fan group 2
Low speed of fan group 3	W02-1	Machine alarm due to low speed of fan group 3
Zero power	W03-1	Machine zero power alarm is normal when light is weak and power is very small, which is not machine
Clock alarm	W16-1	Clock chip failure
Lightning protector alarm	W21-1	Machine alarm due to triggering action of lightning protector

9.1.1 Inverter system error type analysis and solution

Table 9.3 Analysis of system error types and solutions

Problem list and solution	
Error message	Solution
Error of low and high city power voltage; error of low and high city power frequency (F00-F03-1)	①. Confirm whether the safety standards selected for the machine are in compliance with local grid requirements. ②. Inspect whether the AC output terminal is connected reliably and measure whether the voltage is normal with a multimeter. ③. Disconnect the PV input, restart the machine, and see if the machine can return to normal. ④. If fault is not eliminated, contact the distributor.
Error of low and high bus-bar voltage (F04-F05-1)	①. Inspect whether the input mode is correct. ②. Disconnect the PV input, restart the machine, and see if the machine can return to normal. ③. If fault is not eliminated, contact the distributor.
Imbalanced bus-bar voltage (F06-1)	①. Inspect whether the input mode is correct. ②. Confirm the bus-bar voltage imbalance through the LCD display panel. Restart the machine several times every few minutes to see if the machine can return to normal. ③. If fault is not eliminated, contact the distributor.
Error of insulation resistance (F07-1)	①. Disconnect the PV input, restart the machine, and see if the machine can return to normal. ②. Inspect whether the resistance of PV+ and PV- to earth is over 500KΩ. ③. If it is less than 500KΩ, please contact local inverter distributor for solution, or contact battery board supplier for treatment.

System error of failure type

Problem list and solution	
Error message	Solution
Error of high input current (F08-1)	①. Inspect whether the input mode is correct. ②. Disconnect the PV input, restart the machine, and see if the machine can return to normal. ③. If fault is not eliminated, contact the distributor.
Error of high hardware inversion current (F09-1)	①. Inspect whether the input mode is correct. ②. Disconnect the PV input, restart the machine several minutes later, and see if the machine can return to normal. ③. If fault is not eliminated, contact the distributor.
Error of high inversion current (F10-1)	①. Inspect whether the input mode is correct. ②. Disconnect the PV input, restart the machine several minutes later, and see if the machine can return to normal. ③. If fault is not eliminated, contact the distributor.
Error of high AC amount of inversion current (F11-1)	①. Disconnect the PV input, restart the machine several minutes later, and see if the machine can return to normal. ②. If fault is not eliminated, contact the distributor.
Error of high ambient temperature (F12-1)	①. Disconnect the PV input, restart the machine several minutes later until the machine is cooled, and see if the machine can return to normal. ②. Inspect whether the ambient temperature exceeds the normal operating temperature range of the machine. ③. If fault is not eliminated, contact the distributor.
Error of high radiator temperature (F13-1)	①. Disconnect the PV input, restart the machine several minutes later until the machine is cooled, and see if the machine can return to normal. ②. Inspect whether the ambient temperature exceeds the normal operating temperature range of the machine. ③. If fault is not eliminated, contact the distributor.
Abnormal AC relay (F14-1)	①. Disconnect the PV input, restart the machine, and see if the machine can return to normal. ②. If fault is not eliminated, contact the distributor.
Error of low input voltage (F15-1)	①. Inspect whether the PV input wiring mode is correct. In parallel mode of the machine, one line of PV is not connected, and machine error is reported. ②. Disconnect the PV input, restart the machine, and see if the machine can return to normal. ③. If fault is not eliminated, contact the distributor.

System error of failure type

Problem list and solution		
Error message	Solution	
Remote shutdown (F16-1)	The machine is in remote shutdown state. The remote starting and shutdown can be realized with monitoring software.	
SPI1 communication fault (F18-1)	①. Disconnect the PV input, restart the machine, and see if the machine can return to normal. ②. If fault is not eliminated, contact the distributor.	
SPI2 communication fault (F19-1)	①. Disconnect the PV input, restart the machine, and see if the machine can return to normal. ②. If fault is not eliminated, contact the distributor.	
Error of high leakage current (F20-1)	①. Disconnect the PV input, restart the machine, and see if the machine can return to normal. ②. If fault is not eliminated, contact the distributor.	
System error of failure type	Error of self-detection failure for leakage current (F21-1)	①. Disconnect the PV input, restart the machine, and see if the machine can return to normal. ②. If fault is not eliminated, contact the distributor.
	Voltage consistency error (F22-1)	①. Disconnect the PV input, restart the machine, and see if the machine can return to normal. ②. If fault is not eliminated, contact the distributor.
	Frequency consistency error (F23-1)	①. Disconnect the PV input, restart the machine, and see if the machine can return to normal. ②. If fault is not eliminated, contact the distributor.
	Loss of auxiliary power supply (F25-1)	①. Disconnect the PV input, restart the machine, and see if the machine can return to normal. ②. If fault is not eliminated, contact the distributor.
	IGBT Fault (F26-1)	①. Disconnect the PV input, restart the machine, and see if the machine can return to normal. ②. If fault is not eliminated, contact the distributor.
	Error of DSP communication loss (F32-1)	①. Disconnect the PV input, restart the machine, and see if the machine can return to normal. ②. If fault is not eliminated, contact the distributor.

## 9.2 Maintenance

### **⚠ DANGER**

**Risk of inverter damage or personal injury due to incorrect service!**

- Always keep in mind that the inverter is powered by dual sources: PV strings and utility grid.

**Before any service work, observe the following procedure.**

- **Disconnect the AC circuit breaker and then set the DC load-break switch of the inverter to OFF;**
- **Wait at least 10 minutes for inner capacitors to discharge completely;**
- **Verify that there is no voltage or current before pulling any connector.**

### **⚠ CAUTION**

**Keep non-related persons away!**

**A temporary warning sign or barrier must be posted to keep non-related persons away while performing electrical connection and service work.**

### **NOTICE**

**Restart the inverter only after removing the fault that impairs safety performance.**

**As the inverter contains no component parts that can be maintained, never arbitrarily replace any internal components.**

**For any maintenance need, please contact KSTAR. Otherwise, KSTAR shall not be held liable for any damage caused.**

### 9.2.1 Routine Maintenance

Item	Method	Period
System clean	Check the temperature and dust of the inverter. Clean the inverter enclosure if necessary. Check if the air inlet and outlet are normal. Clean the air inlet and outlet, if necessary.	Six months to a year (- depend on the dust contents in air.)
Fans	Check whether there is fan warning using APP. Check whether there is any abnormal noise when the fan is turning. Clean or replace the fans if necessary (see the following section).	Once a year
Cable entry	Check whether the cable entry is insufficiently sealed or the gap is excessively large, and reseal the entry when necessary.	Once a year
Electrical Connection	Check whether all cable are firmly in place. Check whether a cable is damaged, especially the part contacting the metal enclosure.	Six months to a year

### 9.2.2 Maintenance Instruction

#### Cleaning Air Inlet and Outlet

A huge amount of heat is generated in the process of running the inverter. The inverter adopts a controlled forced-air cooling method. In order to maintain good ventilation, please check to make sure the air inlet and outlet are not blocked. Clean the air inlet and outlet with soft brush or vacuum cleaner if necessary.

### Fan Maintenance

**⚠ DANGER**

- **Stop the inverter and disconnect it from all power supplies before maintenance.**
- **Lethal voltage still exists in the inverter. Please wait for at least 5 minutes and then perform maintenance work.**
- **Only qualified electricians can maintain the fans.**

Fans inside the inverter are used to cool the inverter during operation. If the fans do not operate normally, the inverter may not be cooled down and inverter efficiency may decrease. Therefore, it is necessary to clean the dirty fans and replace the broken fans in time.

The operation procedure is as follows:

- step 1 Stop the inverter (see 8.1 Disconnecting the Inverter).
- step 2 Loosen the screw on the sealing plate of the fan module.

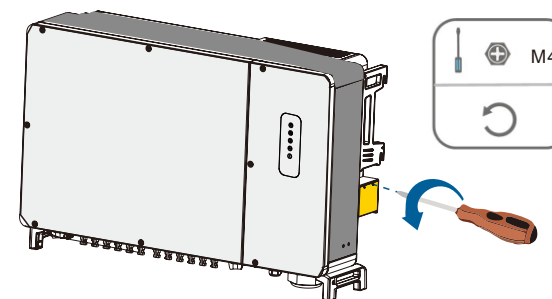

- step 3 Press the hump of the latch hook, unplug the cable connection joint outwards.





step 4 Pull out the fan module, clean the fans with soft brush or vacuum cleaner, and replace them when necessary.

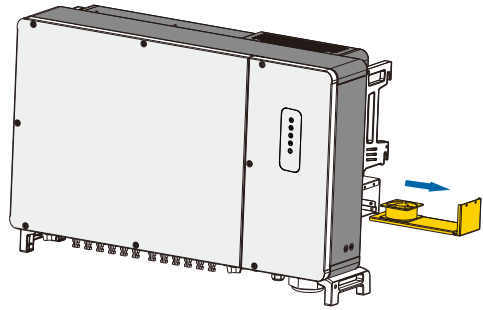

step 5 Follow the steps above to remove the fan on the other side of the inverter.

step 6 Reinstall the fan back to the inverter in reverse order and restart the inverter.

-- End

## 10 Appendix

### 10.1 Technical Date

Parameters	KSG-120CL-M0	KSG-120CL-M3
<b>Input(DC)</b>		
Max. DC voltage	1100V	
MPPT voltage range	180-1000Vdc	
MPPT voltage range at full load	550-850Vdc	
Nominal input voltage	620V	
Start DC voltage	200V	
Number of strings input	20	14
Number of MPPT	10	7
Strings per MPPT	2	2
Max. input current per MPPT	30A	40A
Max. short-circuit current per MPPT	50A	60A
<b>Output(AC)</b>		
Nominal AC output power	120kW	
Max. AC output power	121kW	
Nominal AC voltage	400Vac,320~480V	
AC connection	3W+PE/3W+N+PE	
AC grid frequency range	50/60 Hz(±5Hz)(adjustable)	
Rated output current	173.9A	
Max. output current	174.6A	
Power factor ( cos φ )	0.8 leading ~ 0.8 lagging	
THDi	<3%	

Efficiency	
Max. efficiency	98.7%
Euro efficiency	98.3%
Protection devices	
DC switch	Yes
Anti-islanding protection	Yes
Output over current	Yes
DC anti reverse connection	Yes
String fault Detection	Yes
DC surge protection	Yes
AC surge protection	Yes
Insulation detection	Yes
PID recover	Yes
LVRT	Yes
Physical	
Dimensions (W * H * D)mm	1055 x 700x336
Weight(kg)	93
Operating temperature range	-25°C~ 60°C
Cooling type	Fan cooling
Protection rating	IP66
Humidity	0~100%
Input terminal	Amphenol
Topology	Transformerless
Certification & Standard	
Standard	EN/IEC 62109-1/2;IEC61727;IEC62116; EN 50549;VDE-AR-N-4110

## 10.2 Quality Assurance

When product faults occur during the warranty period, KSTAR or his partner will provide free service or replace the product with a new one.

### Evidence

During the warranty period, the customer shall provide the product purchase invoice and date. In addition, the trademark on the product shall be undamaged and legible. Otherwise, KSTAR has the right to refuse to honor the quality guarantee.

### Conditions

- After replacement, unqualified products shall be processed by KSTAR.
- The customer shall give KSTAR or his partner a reasonable period to repair the faulty device.

### Exclusion of Liability

In the following circumstances, KSTAR has the right to refuse to honor the quality guarantee:

- The free warranty period for the whole machine/components has expired.
- The device is damaged during transport.
- The device is incorrectly installed, refitted, or used.
- The device operates in harsh environment, as described in this manual.
- The fault or damage is caused by installation, repairs, modification, or disassembly performed by a service provider or personnel not from KSTAR or his authorized partner .
- The fault or damage is caused by the use of non-standard or non-KSTAR **components or software**.
- The installation and use range are beyond stipulations of relevant international standards.
- The damage is caused by unexpected natural factors.

For faulty products in any of above cases, if the customer requests maintenance, paid maintenance service may be provided based on the judgment of KSTAR.

## 10.3 Contact Information

### 18 overseas branch offices



☎ PV inverter industry Pre-sales : (86)0755-89741234 Ext 8151

☎ PV inverter industry After-sales : (86)0755-89741234 Ext 8729

✉ Global overseas service mailbox : [overseas\\_service@kstar.com.cn](mailto:overseas_service@kstar.com.cn)